

### ModGSMIII: GSM module for remote control

ModGSMIII module allows to receive information from the **CONTATTO** bus and to send commands using a standard GSM mobile phone.

The way to exchange information with the Contatto bus is based upon the SMS messages (Short Message Service): each sent/received message contains literal strings fully configurable by the user.

In comparison to similar systems based on DTMF tones, ModGSMIII module allows to exclude any misunderstanding about the sent commands and to have clear and explicit information about the status of the system. ModGSMIII contains a "GSM engine" that may operate both with rechargeable and contract SIM cards.

ModGSMIII requires MCP XT controller equipped with main firmware version 3.5 or higher.

The main features of ModGSMIII module are the following:

- **Enabled telephone numbers:** up to 32 telephone numbers may be defined, from which the module accepts SMS to perform commands or to which the module sends information via SMS.
- **Jolly number:** the "jolly number" function allows to a not listed user to send a SMS command to ModGSMIII module, of course provided that before the commands a well defined password has been entered. This password must be always placed at the beginning of SMS and can be freely set using the support software ModGSMTTools.
- **SMS from ModGSMIII to user:** up to 64 SMS may be defined, which will be sent by ModGSMIII module to one or more phone numbers at the occurrence of an event (e.g. alarm system, failure of the boiler, etc.); each one of these SMS can contain information about one or more points of **CONTATTO** bus or about the local input of the module.
- **SMS from ModGSMIII to user at interruption and restoring of the power supply:** thanks to an internal rechargeable battery, ModGSMIII may be set to send a message at the interruption and/or at the restoring of the power supply; these two messages may be defined by the user and they may be individually enabled. This feature does not depend on the bus activity and it is useful to be informed about the status of the electrical network of the plant. At the interruption of the power supply, ModGSMIII module will be automatically switched off after a programmable delay; during this time the local inputs are still working.
- **SMS from ModGSMIII to user at CONTATTO bus failure:** in addition to power supply status information described above, ModGSMIII can be set to send a message at the occurrence of **CONTATTO** bus failure and/or at its restoring
- **Forwarding of SMS from ModGSMIII to user:** ModGSMIII can be set to forward all SMS, received from not listed phone numbers, to one of the listed phone numbers, or to a number not inserted in the list.



- **SMS from user to ModGSMIII for command execution:** up to 64 "command strings" may be defined; each string can execute up to three different actions. Sending a SMS containing one or more of these strings, ModGSMIII module will execute the specified commands, but provided that the SMS has been sent from a listed phone numbers (or from the jolly number). Between the processing of a command string and the next one, the module waits for a pause of 1 second. If a command string is set to perform more actions, these ones will be processed without any pause, so they will be executed almost at the same time. For each command string, at least one action must be defined.
- **SMS from user to ModGSMIII for information request:** the command SMS described at previous point may contain also a request of SMS sending to the user, reporting information about one or more points of the system.
- **SMS from user to ModGSMIII for remaining credit request:** after proper setting, it is possible to send a SMS to force the request of the remaining credit from ModGSMIII to the mobile service provider when using prepaid SIM.
- **Execution of commands by a voice call:** "voice call" is a standard call from any telephone (GSM or wired); if the calling number is among the enabled ones, then ModGSMIII module will reject the calling after a pair of rings without answer to it and it will execute the commands (if enabled) configured for that phone number. This feature allows to execute some commands at zero cost because ModGSMIII, as said, does not answer to the voice call
- **Local inputs and outputs:** ModGSMIII provides 8 inputs, 2 relay outputs (with floating contacts) and 2 NPN outputs, absolutely independent from the **CONTATTO** bus; these points may be used to acquire status and to execute commands regardless of the bus activity.
- **Log on SDCARD:** ModGSMIII performs a daily recording (log) on SDCARD, storing all the significant events occurred during the day.
- **Management of PIN and PUK code by the PC:** it is possible to enable/disable the PIN code of the SIM by using ModGSMTTools programs, avoiding the need to use a third GSM phone. In addition, by PC, it is possible to change the PIN code of the SIM.

**SIM card and battery**

To insert the SIM card remove the front panel. The SIM holder is clearly visible and it is exactly on the GSM engine. The SIM card must be inserted with the electrical contacts oriented toward the bottom side.

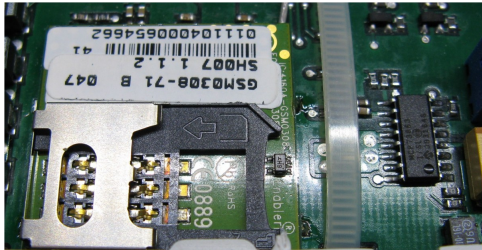

Under the front panel is also located a jumper allowing to connect/disconnect the Li-Ion battery. To avoid the battery discharge, the module is provided with the jumper unplugged; the installer, during the setting up, has to plug the jumper as in the following figure.

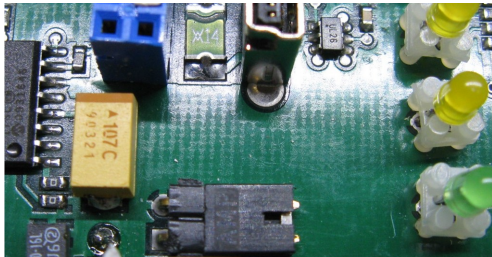

**Address programming**

ModGSMIII module takes, inside the Contatto bus, one 4-channel input addresses, each one providing 16 digital points to be used to perform the commands on the real or virtual output module of the system. In other words, up to 4 x 16 = 64 input points are available; these inputs, instead to be connected to "physical contacts", are driven by the incoming messages (SMS) of ModGSMIII module. These points will be therefore used to perform the desired actions through a proper programming of the Contatto system. The support program ModGSMTTools allows to define the address of ModGSMIII module. No output address are used by this module.

**Note:** it is not possible to assign the bus address of ModGSMIII module by FXPRO programmer.

A white label on the front panel of ModGSMIII allows to write the address assigned to the module for an immediate visual identification.

ModGSMIII must be set by the program ModGSMTTools so that to define the several parameters needed for its proper operation; **for more details refer to the programming manual.**

**Wiring diagram**

A 5-pole removable terminal block on the top side of ModGSMIII module allows the connection to the **CONTATTO** bus and to the related power supply.

A special connector on the top right side allow the connection to the antenna (provided). The antenna must be placed in order to allow a good reception of the GSM signal. The micro SD card is located on the top side, on the left of the antenna connector; this SD card is provided together the module, already inserted and properly configured, therefore **it must not be removed from its holder for any reason, on the contrary the warranty will expire.**

On the bottom left side the module provides: a 4-way terminal block providing 2 potential free contacts (O1 and O2) and a 3-way terminal block for the connection of 2 external relays (O3 and O4); the coil of these relays must be rated for 24V dc current (the voltage on outputs O3 and O4 is about equal to the voltage applied to terminals 13 and 14).

A 9-way terminal block on the bottom right side of the module allows the connection to the 8 local inputs that **must be potential free.**

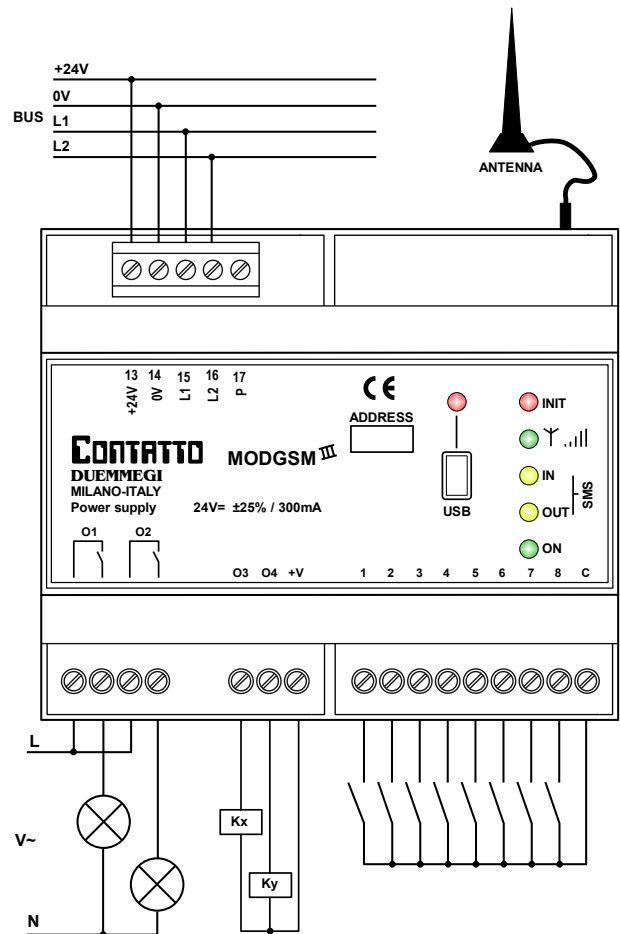

### Meaning of the LEDs on front panel

A small USB connector for the connection of ModGSMIII to the PC is located on the front panel. The red LED located on the top of this connector reports the communication activity between the PC and the module itself. During the communication this LED will flash showing the information exchange.

In addition to this USB communication LED, the following ones are placed on the front panel:

- **LED Init**
- **LED Field** 
- **LED SMS IN**
- **LED SMS OUT**
- **LED Power (ON)**

The following table shows the possible combinations of the LEDs signalling. Fourteen different situations can be identified as listed in the following table. “**FF**” means “**Fast Flash**”, while “**SF**” means “**Slow Flash**”. Of course “**ON**” means that the related LED is fixed ON and “**OFF**” means that the related LED is OFF.

	<b>Init</b>	<b>Field</b>	<b>SMS IN</b>	<b>SMS OUT</b>	<b>ON</b>	<b>USB</b>
1	FF	OFF	OFF	OFF	ON	OFF
2	SF	OFF	OFF	OFF	ON	OFF
3	ON	ON	OFF	OFF	OFF	OFF
4	ON	OFF	OFF	OFF	ON	OFF
5	ON	ON	ON	ON	ON	OFF
6	ON	OFF	OFF	ON	ON	OFF
7	ON	OFF	ON	ON	ON	OFF
8	ON	OFF	SF	SF	ON	OFF
9	ON	OFF	FF	FF	ON	OFF
10	OFF	SF	x	x	ON	OFF
11	OFF	SF	FF	OFF	ON	OFF
12	OFF	SF	OFF	FF	ON	OFF
13	OFF	SF	FF	FF	ON	OFF
14	FF	FF	FF	FF	ON	FF

The listed fourteen possible combinations will be here described:

- 1) It identifies the **initialization of the GSM engine**. The LED “**Init**” flashes quickly, with a period of 0.5 seconds
- 2) It identifies a problem for the internal memory of ModGSMIII module. This may mean that **the memory has not been programmed or that it has been damaged**. The LED “**Init**” flashes slowly with a period of 1 second.

- 3) It identifies the **switching OFF procedure** of ModGSMIII module. It starts this procedure when a power supply failure occurs; in this case the module does not switch OFF immediately, but it follows a sequence that has been set by ModGSMTools program. Therefore, for instance, it sends the SMS related to power failure event and after the defined time delay it completely switches OFF
- 4) It identifies a **communication error with the GSM engine**. In this case the system will force an automatic reboot of GSM engine after 60 seconds fixed delay
- 5) It identifies the **critical errors returned by the SIM card**, requiring a reboot of GSM engine; this will be automatically done after 60 seconds fixed delay
- 6) It identifies **communication problems with the SIM card** currently placed in the module. For instance, the SIM is not properly inserted or a SIM failure occurred. In this case too the system will automatically reboot the GSM engine after 60 seconds fixed delay
- 7) It identifies an **error on entering the PIN code**, for instance the entered PIN code is wrong. In this case the system enters a lock state waiting for the resolution of the error on the PIN code. This requires a proper intervention by ModGSMTools
- 8) It identifies an **error on entering the PIN code**. Unlike the previous case, this error will be reported after a normal start of the GSM engine. The LEDs SMS IN and SMS OUT flash slowly with a period of 1 second. In this case the system will automatically reboot the GSM engine after 60 seconds fixed delay
- 9) It identifies that the remaining **credit of the SIM card expired** and therefore the SIM has to be recharged with a new credit. The LEDs SMS IN and SMS OUT flashes quickly with a period of 0.5 seconds; after 60 seconds delay, the system will reboot the GSM engine. This condition will be repeated at each attempt to send a SMS in expired credit condition
- 10) It identifies the “**normal**” **operation** activity, in other words the operating condition reached after the initialization and with no events pending. The field LED  flashes with a period of 2 seconds and with an ON time in respect to the OFF time (duty-cycle) variable as function of the strength of the GSM signal. More the signal strength and more the LED will be ON during the period
- 11) It identifies the **reception of a SMS**. The LED SMS IN performs a sequence of fast flashes with a period of 0.5 seconds while the field LED continues to flash normally to shows the strength of the GSM signal

- 12) It identifies the **sending of a SMS**. The LED SMS OUT performs a sequence of fast flashes with a period of 0.5 seconds while the field LED continues to flash normally to show the strength of the GSM signal
- 13) It identifies the **reception of a voice call**, both LEDs SMS IN and SMS OUT flash quickly with a period of 0.5 seconds while the field LED continues to flash normally to show the strength of the GSM signal
- 14) It identifies that the procedure of **firmware updating** of the main microcontroller of ModGSMIII module is running. All LEDs, with the exception of ON LED, flashes quickly with a period of 0.5 seconds

### Mapping

By MCP Ide (release 3.0.5 or higher) it is possible to display the map related to ModGSMIII as shown in the figure on the bottom of this page.

Like for all modules of **CONTATTO** family, the background of the module symbol is in green colour if the module is connected and properly operating, else the background will be red.

As said before, ModGSMIII module takes only one input address, 4-channel 16-bit each one (from Ix:1.1 to Ix:4.16). When one of these points becomes active, the related "circle" will be red coloured.

### Messages examples

Granted that the specific programming manual is the unique reference for the configuration of ModGSMIII module, simple examples will be described in the following only to point out some performances of the module.

- **Messages from ModGSMIII to user:** each SMS message transmitted by ModGSMIII may report information about one or more points, both digital and analog ones (e.g. temperature); the composition and the content of the messages are fully configurable by the user through the tool program ModGSMTTools.

This program allows to assign a well defined string to each local input of ModGSMIII and to each **CONTATTO** input and output point (real or virtual or analog or register). In details, the following information must be defined:

- x the **CONTATTO** point to which the string is referred
- x a name (or phrase) to be assigned to the point status when it is at "0" logic level (e.g. "Alarm system normal") or the name of the analog value
- x a name (or phrase) to be assigned to the point status when it is at "1" logic level (e.g.. "Alarm system activated")
- x the event that causes the sending of the message, for each SMS, and to which phone number it must be sent (also more than one phone number)

The following is an example of SMS message that user can receive from ModGSMIII module:



Note as the message reports more information about the Alarm System status and a temperature (this is only an example). Another example of SMS from ModGSMIII to user may be the following:

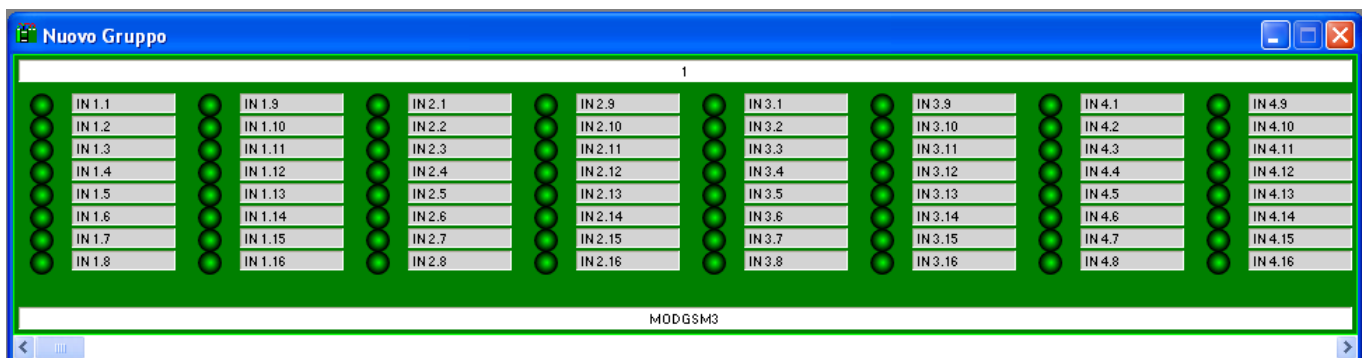
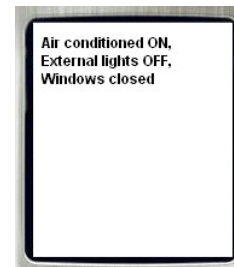

Graphical representation of ModGSMIII in the map of MCP Visio



➤ **Messages from user to ModGSMIII for command execution or information request:** each SMS message sent by the user to ModGSMIII module may contain one or more commands; the commands can act on the local outputs of the module or on one or more of the 64 fictitious inputs provided by ModGSMIII (remember that the module is seen by the bus as an input module with 4 addresses, 16 points each one; these inputs must be used in the **CONTATTO** equations to perform the desired actions).  
The tool program ModGSMTTools allows to define all required information as follows:

- x the string that, once received by ModGSMIII, causes a command (e.g. Close-Shutters)
- x the type of command to be executed; the possible options are:
  - ON (switch ON an input point of ModGSMIII or a local output)
  - OFF (switch OFF an input point of ModGSMIII or a local output)
  - Pulse (causes a pulse on an input point of ModGSMIII or on a local output; the duration of the pulse is 1 second)
  - Send a SMS (cause the sending to the user of a SMS that may be selected among the defined ones)
- x the point on which the selected action must be executed; each point has to be chosen among the 64 fictitious input points or among the 4 local outputs provided by ModGSMIII module
- x a comment to be assigned to the point

The following examples show command messages from user to ModGSMIII module:



In the second example, in addition to “physical” commands, note the string *AlarmStatus* that will cause the sending to the user of a SMS reporting the Alarm System status. This is an example of message containing an information request.

**For more details about the programming, as said before, refer to the specific programming manual of ModGSMIII module.**

**Technical characteristics**

Power supply	24V --- SELV ±25%
Current consumption MAX	0.3A @ 24V
Internal battery	3.6V --- / 1100mAh Li-Ion
Local inputs	8
Current for each input	1mA MAX
MAX voltage on output contacts O1 and O2	60V ---, 250V~
Contact rating (O1 and O2)	1A @ 60V ---, 1A @ 250V~
MIN load on contacts O1 and O2	10mA @ 12V ---
Type and MAX output current on output O3 and O4	NPN, 150mA
+V voltage for supplying external relays	equal to the module supply voltage itself
Occupied address in the <b>CONTATTO</b> bus	1 address, 4-channel 16-bit each one
Number of outgoing SMS	64 + 4 for breaking/restoring of power supply and bus failure/OK
Number of incoming SMS for commands	64, each one with up to 3 different actions
Number of phone numbers for outgoing/incoming SMS	32 plus jolly number
Number of voice call for command execution	1 for each phone number
Additional features:	- forwarding of SMS received from not listed numbers to a chosen number - credit request feature - management of PIN and PUK by PC -LOG on SD CARD
<b>GSM ENGINE DATA:</b>	
Frequency bands	850, 900, 1800 and 1900 MHz
Transmit power	- Class 4 (2W) for 850/900 - Class 1 (1W) for 1800/1900
Sensitivity	-106dBm
SIM interface	slot SIM card 1,8/3V
PC interface	USB
Housing	Standard DIN 6M for DIN rail
Operating temperature	-5 ÷ +50 °C
Storage temperature	-20 ÷ +70 °C
Protection degree	IP20

**Outline dimensions**

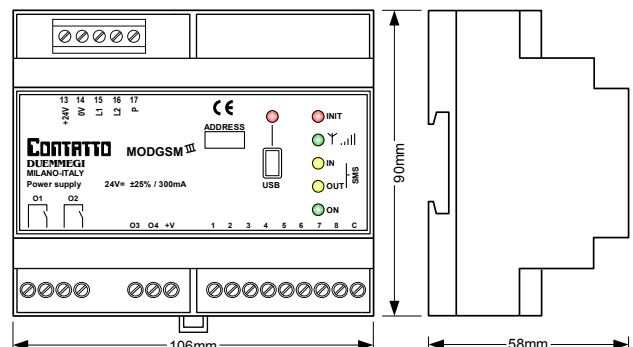

### **Correct disposal of this product**



(Waste Electrical & Electronic Equipment)  
(Applicable in the European Union and other European countries with separate collection systems). This marking on the product, accessories or literature indicates that the product should not be disposed of with other household waste at the end

of their working life. To prevent possible harm to the environment or human health from uncontrolled waste disposal, please separate these items from other types of waste and recycle them responsibly to promote the sustainable reuse of material resources. Household users should contact either the retailer where they purchased this product, or their local government office, for details of where and how they can take these items for environmentally safe recycling.

This product and its electronic accessories should not be mixed with other commercial wastes for disposal.

Specifically about the battery, check local regulations for correct disposal. Never use municipal waste.

### **Installation and use restrictions**

#### **Standards and regulations**

The design and the setting up of electrical systems must be performed according to the relevant standards, guidelines, specifications and regulations of the relevant country. The installation, configuration and programming of the devices must be carried out by trained personnel.

The installation and the wiring of the bus line and the related devices must be performed according to the recommendations of the manufacturers (reported on the specific data sheet of the product) and according to the applicable standards.

All the relevant safety regulations, e.g. accident prevention regulations, law on technical work equipment, must also be observed.

#### **Safety instructions**

Protect the unit against moisture, dirt and any kind of damage during transport, storage and operation. Do not operate the unit outside the specified technical data.

Never open the housing. If not otherwise specified, install in closed housing (e.g. distribution cabinet). Earth the unit at the terminals provided, if existing, for this purpose. Do not obstruct cooling of the units. Keep out of the reach of children.

#### **Setting up**

The physical address assignment and the setting of parameters (if any) must be performed by the specific softwares provided together the device or by the specific programmer. For the first installation of the device proceed according to the following guidelines:

- Check that any voltage supplying the plant has been removed
- Assign the address to module (if any)
- Install and wire the device according to the schematic diagrams on the specific data sheet of the product
- Only then switch on the 230Vac supplying the bus power supply and the other related circuits

### **Applied standards**

This device complies with the essential requirements of the following directives:

2004/108/CE (EMC)

2006/95/CE (Low Voltage)

2002/95/CE (RoHS)

EN 55022 Class B

FCC Parts 15,22 & 24, Class B

3GPP TS 51010-1, Section 12.2

### **Note**

Technical characteristics and this data sheet are subject to change without notice.