

ALARMS AND TEXT DISPLAY

DISP 16D



User's manual

Note

Rel.: 1.2 – January 2002

- Information in this document may be modified without notice.
- MS-DOS and WINDOWS are registered mark of Microsoft Corporation.
- For additional details contact: **DUEMMEGI** srl, via LONGHENA 4 - 20139 MILANO
Tel.: 02 / 57.30.03.77 – Fax: 02 / 55.21.36.86

INDEX

1- INTRODUCTION	3
2- DISP 16D: GENERAL CHARACTERISTICS	3
3- CONNECTIONS	4
3.1- Electrical insulation of the inputs	5
4- OUTLINE DIMENSIONS.....	5
5- TECHNICAL DATA	6
6- FUNCTIONAL DESCRIPTION	6
6.1- Operating modes	7
6.2- Input logic.....	7
6.3- Centralized alarm relay.....	7
7- PUSHBUTTONS FUNCTION	7
8- ALARM HANDLING	8
8.1- RESET of pending alarms	8
9- PROGRAMMING	8
9.1- Manual programming by the panel pushbuttons	8
9.2- Programming by Personal Computer	10
9.3- Syntax of message file.....	11

1- INTRODUCTION

DISP family of **DUEMMEGI** displays allows to show custom messages in many applications, such as industrial and domestic plants, hospital, electrical machines, etc..

Thanks to the flexibility of these devices, the displays of **DISP** family make easy to understand any information related to the occurrence of alarms or events.

DISP devices may be employed in many applications; in example:

- Electrical machines
- Industrial plants
- Domestic plants
- Building automation
- Signalling of alarm and/or operating status

The following models are available:

DISP 16D	16 messages display driven by direct inputs
DISP 15B	15 messages display driven by binary-coded inputs
DISP 31B	31 messages display driven by binary-coded inputs
DISP 63B	63 messages display driven by binary-coded inputs
DISP 127B	127 messages display driven by binary-coded inputs
DISP 255B	255 messages display driven by binary-coded inputs
DISP-S	500 messages display driven by RS232 or RS485 serial input and printer output
DISP BUS	250 messages display for DUEMMEGI Contatto bus system

This manual refers to **DISP 16D** model.

2- DISP 16D: GENERAL CHARACTERISTICS

LCD display 2 x 16 characters with back-lighting
Message programming by front panel pushbuttons or by PC
Insulated inputs
16 messages, each one made by 2 main lines and 2 hidden lines
1 base message made by 2 lines (stand-by message)
1 alarm pending message made by 2 lines
Events storing (MEM mode) or real time display (NOMEM mode)
Events are displayed in chronological order
Information about the total amount of pending alarms
ACK and RESET commands from front panel pushbuttons
1 potential free contact (internal relay) for alarm warning

3- CONNECTIONS

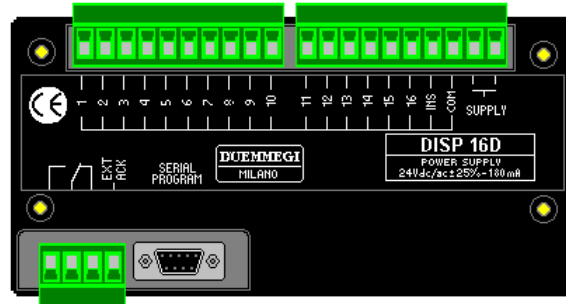

Description of the connections:

1 – 16	Input terminals: each input is activated applying a positive voltage to the related terminal; if the electrical insulation of inputs is not needed, the COM terminal may be used to supply the inputs (through free potential contacts). The status of each input, to be accepted, must be stable for 50 msec minimum
INS	This terminal allows the electrical insulation of the inputs (see next paragraph); connect this terminal to 0V of the external voltage source used to supply the input terminals
COM	Positive voltage output to be used as common terminal of the contacts connected to the inputs
SUPPLY	Power supply input: 24 Vac/dc \pm 25% (automatic polarity)
SERIAL PROGRAM	Connector for the serial programming from PC
ALARM CONTACT	Relay output contact to control an external alarm device (e.g. siren)
EXT ACK	Input for remote acknowledgement pushbutton; the external pushbutton must be connected to this terminal and to «COM» (but only if the electrical insulation of the inputs is not needed)

3.1- Electrical insulation of the inputs

The inputs may be electrically insulated from the supply terminal; to do this, move the internal jumper as shown in the first case of the figure on the right side, and connect the 0 volt terminal of the external supply source to the terminal «INS» of DISP 16D. If the electrical insulation is not needed, use terminal «COM» to supply the external contacts connected to the inputs, and move the jumper as shown in the second case of the figure.

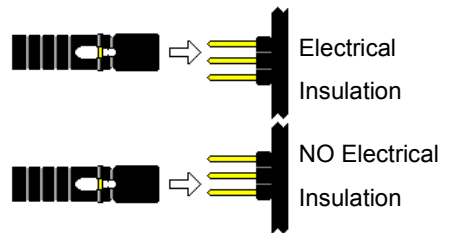
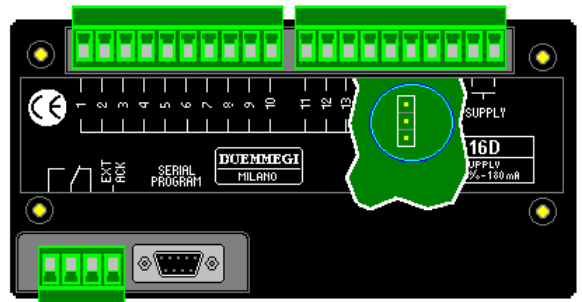

4- OUTLINE DIMENSIONS

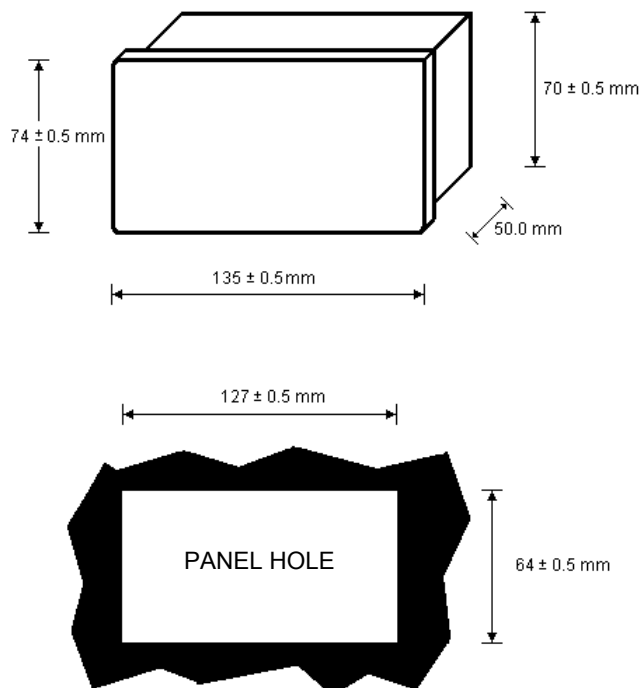

5- TECHNICAL DATA

Power supply	24Vdc ± 25%
Current consumption	All input de-activated: 70mA MAX All input activated: 180mA MAX
Display	LCD with back-lighting and contrast adjust by front panel
Characters (each line)	16
Lines	2
Characters height	8 mm
Inputs	16
Number of messages	16 (4 lines each one) + 1 made by 2 lines (stand-by message) + 1 made by 2 lines (alarm pending message)
Connections	By removable terminal blocks
Protection degree	Front: IP 53 – Back: IP20
Allowed input voltage	10 ÷ 30 Vdc

Alarm output contact:

Max switching voltage	60Vdc or 125Vac
Max switching current	1A
Max operating power	30W in dc – 60VA in ac

6- FUNCTIONAL DESCRIPTION



DISP 16D shows, at power-on and during 1 second about, the type and the firmware version (e.g. as shown by the following figure).



When no alarms are pending, the stand-by message is displayed (line 1 and line 2 of the message number zero). At the activation of an input, the related message will be recalled from the internal memory and shown on the display (line 1 and 2).

This message will be cyclically displayed together to the alarm pending message (line 3 and line 4 of the message number

zero) with 2 seconds period. Pressing the button  it is possible to change between automatic and manual displaying; in manual mode, it is possible to display the previous and the

following messages using the buttons  and .

If another input is activated, the related code will be added to the displaying cycle (queue). All pending messages will be displayed in chronological order as they occur. The first message after the alarm pending message is the first occurred event, the next one is the second and so on. The number on the bottom left side in the alarm pending message is the total amount of the alarms occurred from the last reset of DISP 16D.

6.1- Operating modes

MEM (memory):

The input activation occurrence will be stored; in other words, the related message remains in the queue even if the input has been de-activated.

NOM (no memory):

The displaying cycle shows the current condition of the inputs; this means that the message will be automatically removed from the queue when the related input is de-activated.

The memory or no-memory mode may be set assigning to the first three characters of the message 000,4 the label MEM or NOM (see the paragraph on the programming procedure).

The cyclic displaying occurs both in MEM and NOM mode, but in the first case will be cycled the messages related to the inputs activated after the last reset, while in the second case will be cycled only the messages currently activated.

6.2- Input logic

The line 0 of message 0 allows defining the operating logic for each of the 16 inputs by assigning the characters + or - ; the first characters on the left of the line is referred to input 1, the last one is referred to input 16. The logic rule is the following:

- + The message is recalled at the closing of input contact (positive logic)
- The message is recalled at the opening of the input contact (negative logic)

6.3- Centralized alarm relay







The internal relay is energized at the activation of any input. If MEM mode has been selected, the relay remains energized until the pressing of ACK button.

If NOM mode has been selected, the relay will be de-energized at the pressing of ACK button or as soon as all inputs return in the steady state.

If the 16th character of line 1 of a message is the symbol #, then the activation of the related input will have not any effect on the centralized alarm relay.

7- PUSHBUTTONS FUNCTION

The 6 pushbuttons on the front panel, during normal operation, perform the following functions:

	ACK: acknowledge, siren silencing and displaying of the first occurred event
	Request of queue reset; the confirmation must occur within 2,5 seconds by pressing the ACK button
	Show next message when the automatic cyclic displaying of messages is disabled
	Show previous message when the automatic cyclic displaying of messages is disabled
	Switch from the automatic to manual displaying of messages and vice-versa. DISP 16D returns to automatic mode when a new alarm occurs
	Show the auxiliary lines of the current message (lines 3 e 4 of each message)

During the programming mode, these pushbuttons perform other functions; refer to the related paragraph for details.

8- ALARM HANDLING

If the no memory mode has been selected (NOM), the displayed messages show the current condition of the inputs, in the chronological order as they have been activated.

If the memory mode has been selected (MEM), the displayed messages show the inputs that have been activated from last reset procedure, in the same chronological order as they occurred.

This last operating mode is therefore suggested when handling temporary alarms.



8.1- RESET of pending alarms

If the chosen operating mode is without storing (NOMEM), the RESET sequence has no relevance.

On the contrary (MEM mode), the RESET sequence allows to restore the situation; this means that all alarms that are not still active will be removed from the queue.

The RESET procedure is the following:



- silence the siren by pushing  button
- push  button; DISP 16D will displays the text shown in the left-side figure
- push  button to confirm the RESET of the message queue

If the confirmation does not occur in 2,5 seconds, the RESET request will be automatically rejected.

9- PROGRAMMING

9.1- Manual programming by the panel pushbuttons

The message programming may be executed by the front panel keyboard of DISP 16D. To enter the programming mode, switch on DISP 16D while pressing down both  and  buttons.





During the manual programming the display shows the number of the current message and the number of the current line on the first line, and the text of the related message on the second line. First displayed line is 000,0 (message 0 line 0) and it is related to the input logic programming.

The programming procedure counts two operating modes:













- message searching
- message edit

These modes can be easily identified because in the edit mode a cursor under the current character to be edited is shown (the cursor is a small line under the character); the cursor is not displayed during searching mode.









In the searching mode the pushbuttons perform the following functions:

	Next message
	Previous message
	Enter the edit mode
	Enter the edit mode (same function as previous button)

In the edit mode the pushbuttons perform the following functions:

	Next character
	Previous character
	Move cursor to right
	Move cursor to left
 + 	Copy current character to left-side position
 + 	Copy current character to right-side position
 + 	Insert character «A» at the cursor position
 + 	Insert symbol «#» at the cursor position

Valid Functions for both modes:

 + 	Copy current message in the clipboard
 + 	Paste the message from the clipboard to the current message
 + 	Quit programming
 + 	Save the current message

9.2- Programming by Personal Computer

DISP 16D features a DB9 connector on the rear side to communicate with a Personal Computer through the RS232 serial port.

The required connection cable is a standard type with 9-pole male connector at one edge and 9-pole female connector at the other edge. The two connector must be pin to pin connected (pin 1 to pin 1, pin 2 to pin 2, etc.).

Programming by PC

DISP 16D programming by PC can be performed in two ways:

- from **WINDOWS** using the tool program “DISP” free-distributed by **DUEMMEGI**
- from **MS-DOS**

Use of tool program “DISP” is more simple and more efficient than the MS-DOS option, so it may be preferred; for details on the use of this program, refer to its on-line help.

When the tool program “DISP” is not available, use, in MS-DOS mode, the procedure here bottom described.

The serial programming by PC in MS-DOS mode is performed in 2 steps:

- writing of a file containing the messages to be displayed and the settings
- downloading of the file to the memory of DISP 16D

Regarding to the first step, see next paragraph; the sequence of file downloading is here bottom described:

Connect the serial port COM1 (or COM2) of PC to DISP 16D by a standard RS232 cable (9-pole, pin to pin connected). Before to switch on DISP 16D, set the serial port **COM1** digitizing on the keyboard of PC the following commands:

- MODE COM1:1200,N,8,1 <enter>
- DEBUG <enter> (the prompt – will appear)
- O 3fc 3 <enter> (the first characters of this command is O, not zero)
- Q <enter>

If using the serial port **COM2**, the proper commands are the following:

- MODE COM2:1200,N,8,1 <enter>
- DEBUG <enter> (the prompt – will appear)
- O 2fc 3 <enter> (the first characters of this command is O, not zero)
- Q <enter>

At this point, switch on DISP 16D; the file containing the messages will be downloaded by the following command:

- COPY FILE.MSG COM1: <enter> (when using COM1)
- COPY FILE.MSG COM2: <enter> (when using COM2)

FILE.MSG is the name of the file containing the messages (FILE may be any other name, limited to 8 characters).

To quit the programming mode, remove RS232 cable. During programming, the display shows the message “RS232 PROGRAM” on the first line and a animated bar on the second line to give an indication of the percentage of the elapsed time against the total time required.

If an error occurs during programming, the message “ERROR ⇒ABORTED” will be displayed on the second line. In this case, switch off DISP 16D to quit the error condition and check that the file does not contain syntax errors. When DISP 16D detect that the PC does not send any other character, it assumes that the programming sequence is ended and it shows on the second line the message “⇒COMPLETED”.

To return to normal operating mode, remove RS232 cable; on the contrary, if a new downloading is required, switch off and then switch on again DISP 16D.

9.3- Syntax of message file

The file containing the message is an ASCII file and it may be written using any text editor (e.g. EDIT of MS-DOS). Each line is made by the message number, 16 characters of the text to be displayed and optional comments, separated by commas:

MMM,L, MESSAGE TEXT , comment

The following syntax is mandatory:

The line must start with the message number MMM (in the range 000 to 255)
MMM must be in 3 digit format
L (line number) must be in the range 1 to 4 (with the exception of message 000,0 defining the input logic)
MESSAGE TEXT must contain 16 characters (no one more, no one less); if last character of line 1 of a message is the symbol «#», then the siren will be disabled for that message
Commas before and after the line number L are mandatory
Any characters after the 16 th will be considered as a comment and will be ignored during the download to DISP 16D

Empty lines are not allowed. The file may contain only part of the messages (it is not required to program all available messages).

Message 000 is reserved for stand-by message, alarm pending message and settings; more precisely:

Message 000,0 defines the input logic. Character «+» (plus) means normally open contact, character «-» (minus) means normally closed contact
Messages 000,1 and 000,2 are the two lines displayed when no alarms are pending (stand-by message)
Messages 000,3 and 000,4 are the two line displayed after the last occurred alarm (alarm pending message) during the cyclic displaying of the alarms. The first three characters of line 000,4 set the DISP 16D operating mode (MEM for memory mode or NOM for no memory mode). During the cyclic displaying of more alarms, these three characters will be replaced by the total amount of occurred alarms.

Example of message file:

```
000,0,+++++++-----,the first 8 input are connected to NO contact, the other to NC
000,1, NO ALARM      ,stand-by message, line 1
000,2, PENDING      ,stand-by message, line 2
000,3, WARNING      ,alarm pending message, line 1
000,4, MEM ALARMS   ,alarm pending message, line 2 and selection of MEM mode
001,1, FAULT PUMP   ,message 1, line 1
001,2, BOILER ROOM  ,message 1, line 2
001,3, CALL HYDRAULIC ,message 1, line 3
001,4, 01/647589    ,message 1, line 4
002,1, TANK H20     #,message 2, line 1, siren disabled for this input
002,2, EMPTY        ,message 2, line 2, siren disabled for this input
002,3, OPEN         ,message 2, line 3, siren disabled for this input
002,4, COCK 1       ,message 2, line 4, siren disabled for this input
```