

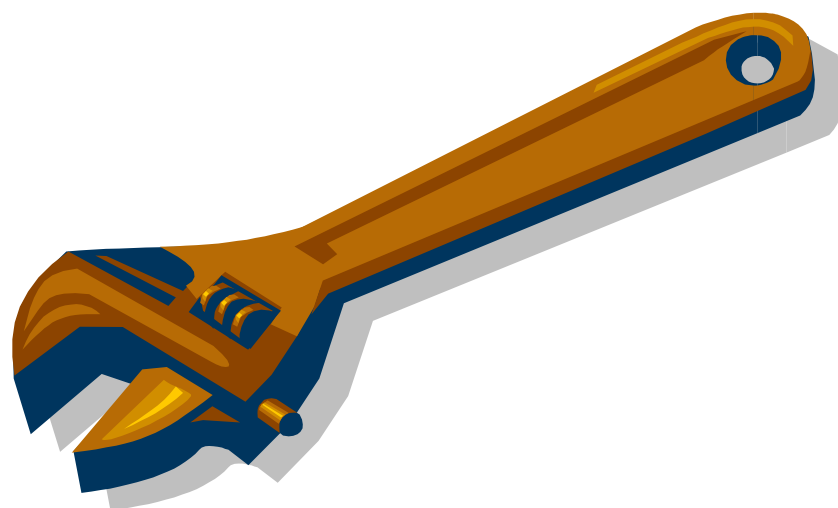

# CONTATTO

# bus system



**General description, operation, setting up and maintenance**

Release 2.1 - January 2013

**DUEMMEGI**   
HOME AND BUILDING AUTOMATION  
Via Longhena 4 - 20139 MILANO  
Tel. 02/57300377 - FAX  
02/55213686  
[www.duemmegi.it](http://www.duemmegi.it)

**INDEX**

A1- Information about installation use restrictions.....	3
A2- Applied standards.....	3
A3- Correct disposal of the product (waste electrical and electronic equipment).....	3
1- DESCRIPTION OF Contatto BUS SYSTEM.....	4
1.1- Structure.....	4
1.2- Configuration.....	5
1.3- Data exchange between modules.....	5
1.4- Communication line.....	5
1.5- Addresses programming.....	7
2- SETTING UP.....	9
2.1- Preliminary operations.....	9
2.2- Power supply and current consumption.....	10
2.3- Installation.....	11
2.4 Distribution of power supply by groups.....	11
2.5 Testing.....	12
3- DIAGNOSTIC.....	12
3.1 Visual diagnostic by the LEDs on MCP XT .....	12
3.2 Visual diagnostic by the LEDs on MCP MOD or MCP Plus .....	13
3.3- Diagnostic by PC and MCP Ide or MCP Tools.....	13
4- TROUBLE SHOOTING.....	14
4.1- MCP reports BUS.F.....	14
4.2- MCP reports MOD.F.....	15
4.3- VAR led on MCP is always ON or frequently blinking.....	16
4.4- One or more digital input modules do not communicate to MCP the correct status of their inputs.....	16
4.5- One or more digital output modules do not control correctly the outputs.....	17
4.6- Checking the voltages on the bus lines L1 and L2.....	17
4.6.1- FXPRO2 is available.....	17
4.6.2- FXPRO2 is not available.....	19

## A1- Information about installation use restrictions

### Standards and regulations

The design and the setting up of electrical systems must be performed according to the relevant standards, guidelines, specifications and regulations of the relevant country. The installation, configuration and programming of the devices must be carried out by trained personnel.

The installation and the wiring of the **CONTATTO** bus line and the related devices must be performed according to the recommendations of the manufacturers (reported on the specific data sheet of the product) and according to the applicable standards. All the relevant safety regulations, e.g. accident prevention regulations, laws on technical work equipment, must also be observed.

### Safety instructions

Protect the unit against moisture, dirt and any kind of damage during transport, storage and operation. Do not operate the unit outside the specified technical data. Never open the housing. If not otherwise specified, install in closed housing (e.g. distribution cabinet). Earth the unit at the terminals provided, if existing, for this purpose. Do not obstruct cooling of the units.

### Installation

When reported on the specific data sheet of the product, follow the suggestion about installation. Generally, install the modules in easily accessible location, in order to allow an adequate inspection and maintenance. Install the modules far from heat and humidity sources.

### Setting up

The physical address must be assigned with the specific programmer and the setting of parameters (if any) must be performed by the specific configuration softwares; for more details refer to the specific data sheet of the product. For the first installation of the device, generally and unless otherwise specified on the specific data sheet of the product, proceed according to the following guidelines:

1. Check that any voltage supplying the plant has been removed
2. Assign the address to module (if any)
3. Install and wire the device according to the schematic diagrams on the specific data sheet of the product
4. Only then switch on the 230Vac supplying the bus power supply and the other related circuits

### Maintenance

Check periodically the status of the visual signaling on the panel of MCP microcontroller, with special care to MOD.F and BUS.F LEDs that, in normal conditions, must be OFF; if these LEDs are not OFF, refer to the section "Trouble shooting" on this manual. Check periodically that power supplies are well aerated; for the models with one or more cooling fans, check that the related openings are not obstructed, in that case remove the dust using a vacuum cleaner. Check that the power supply voltage of the bus system is in the correct range ( $24V = \pm 25\%$ ).

Unless otherwise specified on the specific data sheet of the product, the modules do not require any special maintenance. In case of damage (regardless of the cause) avoid any repairing action. The opening of the module will cause the expiration of the guarantee.

## A2- Applied standards

The devices belonging to **CONTATTO** line comply with the essential requirements of the following directives:

2004/108/CE (EMC)  
2006/95/CE (Low Voltage)  
2002/95/CE (RoHS)

## A3- Correct disposal of the product (waste electrical and electronic equipment)



(Applicable in the European Union and other European countries with separate collection systems).

This marking on the product, accessories or documentation indicates that the product and its electronic accessories should not be disposed of with other household waste at the end of their working life. To prevent possible harm to the environment or human health from uncontrolled waste disposal, please separate these items from other types of waste and recycle them responsibly to promote the sustainable reuse of material resources. Household users should contact either the retailer where they purchased this product, or their local government office, for details of where and how they can take these items for environmentally safe recycling. Business users should contact their supplier and check the terms and conditions of the purchase contract. Adequate disposal of the decommissioned equipment for recycling, treatment and environmentally compatible disposal contributes in preventing potentially negative effects on the environment and health and promotes the reuse and/or recycling of equipment materials. Abusive product disposal by the user is punishable by law with administrative sanctions.

contact their supplier and check the terms and conditions of the purchase contract. Adequate disposal of the decommissioned equipment for recycling, treatment and environmentally compatible disposal contributes in preventing potentially negative effects on the environment and health and promotes the reuse and/or recycling of equipment materials. Abusive product disposal by the user is punishable by law with administrative sanctions.

## 1- DESCRIPTION OF **CONTATTO** BUS SYSTEM

### 1.1- Structure

**CONTATTO** is a modular system allowing to manage a certain number of inputs and outputs, both of analog and digital type, minimizing the physical connections to be done, thus making easy the installation and future modifications and expansions.

The system is basically made by the following types of module:

- ✓ programmable control module MCPXT or MCP MOD or MCP Plus (one for each bus line)
- ✓ input modules
- ✓ output modules
- ✓ input/output mixed modules
- ✓ special modules

The modules are connected together by a 4-wire bus, as in the following figure.

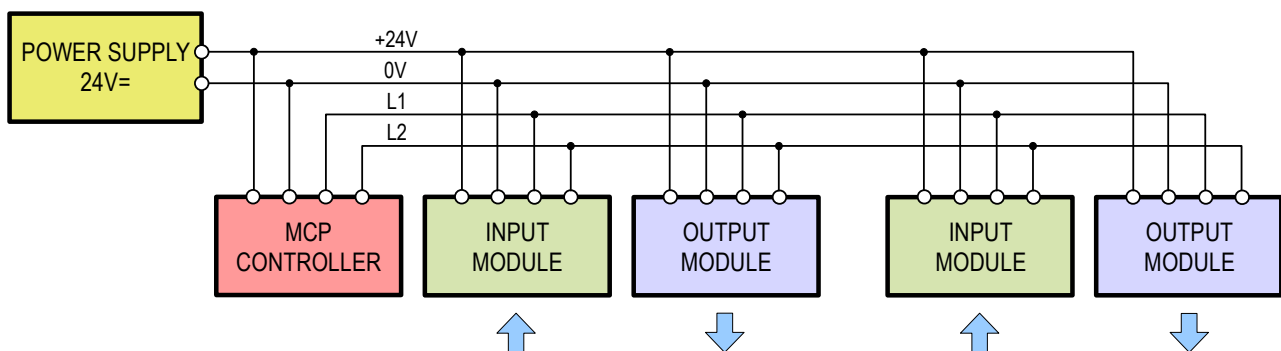

Each module of **CONTATTO** system is well identified inside the bus through a number, in the range 1 to 127, called **address**, that can be freely assigned by the specific programmer (FXPRO or FXPRO2) and stored inside the non volatile memory of the module itself; this memory can also contain other configuration data, if required.

The user program, loaded in the controller, can contain free associations between inputs and outputs, introducing all relations normally used in the electrical installations (AND, OR, NOT, Toggle, Set-Reset, counters, timers, thresholds on analog inputs, clocks, etc.). For the program developing, the simulation, the transferring to the controller and the setting up, a specific software package named MCP Ide (MCP Tools for MCP MOD and MCP Plus) is provided. It is possible to realize very complex installations using MCP controllers, with the possibility to expand the system up to the realization of a complete remote management through a WEB Server.

Moreover, thanks to the MODBUS protocol integrated in MCP XT and MCP Plus, in addition to the proprietary FXP protocol, it is possible to interface to a big number of control and supervision systems that can be found on the market, touch screen video-terminals included.

MCP controllers provide a lot of variables (virtual points, registers, counters, timers) and a lot of functions. MCP XT controller also allows the complete control of the internal RAM (also featuring the battery backup) allowing to decide the status that each memory cell must assume after a disconnection of the system power supply. For complex functions, MCP XT controller can be programmed also by using the SCRIPTs, that are block of program written in a language very simple and similar to Basic.

MCP XT controller allows to manage the new "intelligent" modules belonging to **CONTATTO** family, present (e.g. MODHT, MODTPD, MODCL, MODDALI, MODDMX, etc.) and future thank to the possibility to upgrade the firmware in any moment, also on the plant, by the user in simple and quick way.

## 1.2- Configuration

The system can be configured by a number and type of modules according to the specific application. The heart of each **CONTATTO** system is the Programmable Control Module (MCP) which can manage **up to 127 input addresses and 127 output addresses**; considering the simplest input and output digital modules, performing 8 points each one, it is possible to manage 1016 (127x8) input points and 1016 output points. Using more MCPXT controllers, considering that up to 31 of them can be connected together in a network, it is possible to manage up to 31.496 (127x8x31) inputs and 31.496 outputs.

This calculation is purely theoretical because modules with 16 points and 4 channels are also available, thus increasing the number of points that can be managed.

## 1.3- Data exchange between modules

MCP controller, one for each system, manages the data exchange between the input modules and the output modules; in details, the controller sends a data request to each input module, then it processes the information according to the loaded program and then sends the proper commands to the output modules. This cyclic inquiry made by the control module is called "polling".

In addition, each input module, in any moments, can send a message to MCP to report a change of one or more inputs in respect to the previous status; this mechanism, called autonomous transmission of the input module due to a status change, allows to reduce drastically the response times in respect of systems based on the cyclic polling only. The typical response time of the Contatto system can be evaluated in **30ms** about, and this time does not depend on the number of modules connected to the system.

Resuming, the communication between the control module and the input/output modules can be established through one of the following modes:

- ✓ input status request (polling) from the controller to an input module which answers sending the status of its inputs in that moment
- ✓ sending of the commands from the controller to output modules
- ✓ communication of a status change from an input module to the controller, which answers with an acknowledgement message and sends the new command to the associated output module

MCP also manages the system diagnostic, reporting possible fault modules and other anomalies.

## 1.4- Communication line

The modules are connected each one to other by a 4-wire line, two of them for the modules power supply and the other two for the data exchange. The location of the input, output and controller modules can be chosen by the user along the 4-wire communication line, according to the installation requirements.

The ability to exchange information between modules without errors requires immunity to electrical noise induced on the communication line. Generally, the serial data exchange from a transmitting unit to a receiving unit can be established through one wire or two wires.

In the first case the noise immunity is very poor, especially on long lines; the electrical noise induced on the line appears on the receiver output like in the first case of the following figure.

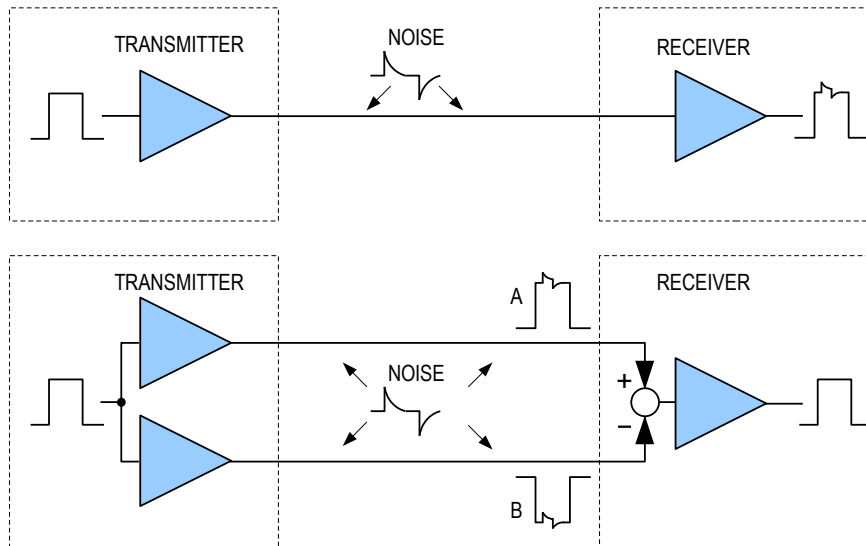

**CONTATTO** system uses instead a 2-wire line, called ***balanced or differential data transmission line***; in this case the signal voltage on a wire is always equal to the signal voltage on the other wire, but with opposite sign. The second case in the previous figure shows what happens when an electrical noise pulse is induced on the bus: the noise voltage appears to the receiver as common mode signal; this means that the noise pulse will appear with the same amplitude and the same polarity on both wires. Because the receiver has a differential input, the output signal will be the difference between signal A and signal B; the receiver, removing as we just said the noise pulse, reconstructs the original signal.

*For a good efficacy of the just described communication method, a twisted pair for the 2 wires of the communication line is recommended, at least for long lines.*

The length of **CONTATTO** bus can reach without problems **1.5 Km** using a standard 4-wire cable, for example 4x1,5mmq; higher distances can be covered by using of specific repeater modules. **Avoid to use shielded cable** because its impedance strongly decreases the maximum allowable length.

### 1.5- Addresses programming

The address of input and output modules must be assigned by the specific programmer **CONTATTO FXPRO** or **FXPRO2**, which allows to set the desired address number in the non volatile memory of the modules.

Assigning the address **by FXPRO** is very easy and does not require the opening of the modules; to program the module, insert the programmer connector in the bus terminal block (1), set the desired address number (2) and press the program push-button (3).

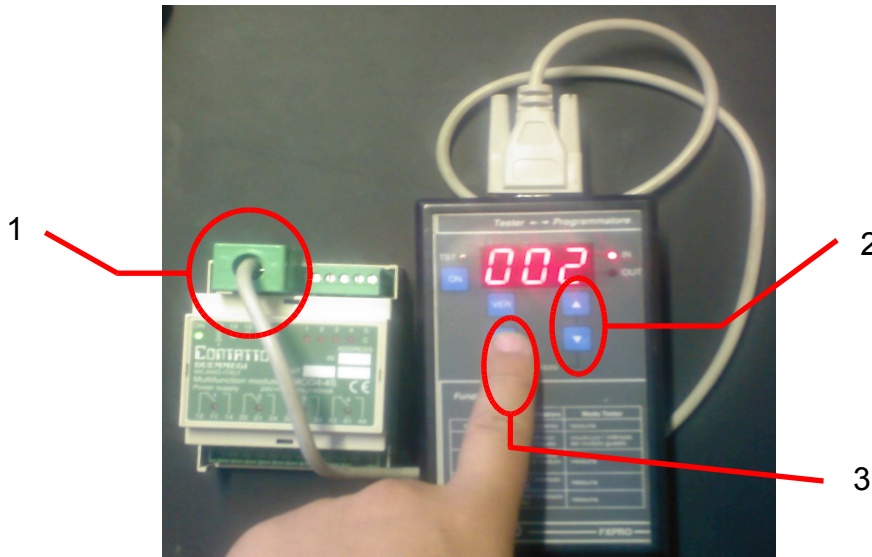

Act on the push-buttons (2) in order to show on the display of FXPRO the number corresponding to the desired address to be assigned to the module. If the module is only input or only output type, this is enough. On the other hand, if the module is a mixed input/output type, it is required to decide what is the address to be assigned to input section and to output section; the type of address (input or output) is shown by the two LEDs on FXPRO called IN and OUT.

TO check or read the address (or the addresses) that has been assigned to a module, press the push-button VER (one or more time depending on how much addresses the module takes).

Assigning the address **by FXPRO2** is similar.

Connect FXPRO2 directly to the bus terminal of the modules or to the special connector in the case of some particular modules, as shown in the figure on this right side. At power on, after the screen showing the version number, the main menu will be entered:

```
> Address Management
  Tester
```

Choose the option Address Management and push **OK**.

```
> Prg/Ver Indirizzo
```

Push **OK** to access to the Address Management section.

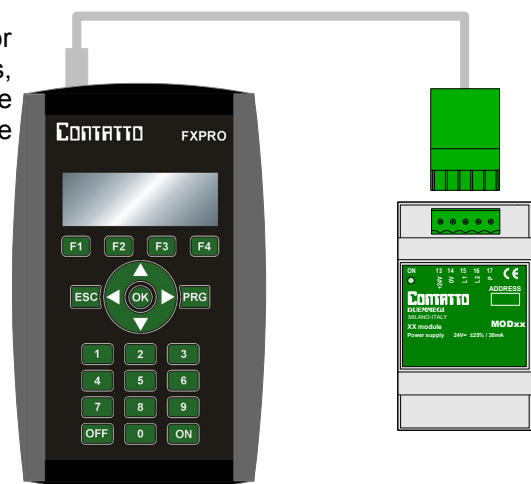

To assign the input address be sure that the first line shows Input Module as follows:

```

Input Module
Address      = 001
PRG  VER    I/O
    
```

If not, push **F4** (corresponding to the item I/O on the display).

Enter the desired address (using 3 digits) through the numerical keys, connect FXPRO2 to the module and press **PRG** or **F1** (corresponding to the PRG item on the display).

After having assigned the address, it is NOT necessary to verify it because this is done automatically by FX-PRO2.

If the module is not connected, or if its not well operating or if it is not compatible, then the display will show:

```

!      ERROR!      !
! NO ACKNOWLEDGE !
!   OR MODULE    !
! NOT COMPATIBLE !
    
```

To verify or read the address press **F2** (corresponding to the item PRG on the display). FXPRO2 will execute a scan until the address of the connected module will be found (or one of the addresses if the module has more than one address). The display will show the found address and its type (input or output):

```

Output Module
Address      = 001
PRG  VER    I/O
    
```

Push again the key **F2** if the module has more than one address. If no address will be detected, push **ESC** to stop the scan.

For more details on FXPRO2 refer to the related technical sheet.

**Notes:**

- For address assignment to special modules refer to the related technical data sheet
- MCP controllers do not have any bus address



## 2- SETTING UP

### 2.1- Preliminary operations

Once defined the number of modules required by the specific application, the address of each module has to be programmed. This operation requires the following tools:

- ✓ **CONTATTO** FXPRO or FXPRO2 programmer with its cable
- ✓ permanent marker

**Note:** the address assignment described in the following procedure refers to FXPRO; if using FXPRO2 the address assignment will be as described in the previous paragraph 1.5.

After having produced the required documentation about the location of the modules and the address to be assigned to them, proceed as follows:

1	write on the label of each input module, using the permanent marker, the address to be assigned to the module itself
2	repeat the previous step for each output module
3	connect the programming cable to the connector of the <b>CONTATTO</b> programmer
4	turn on the <b>CONTATTO</b> FXPRO programmer pushing <ON> button; the display will show its release number during 2 seconds about, then it will show [001]; the TST led must be off
5	insert the connector on the other edge of the programming cable in the 5-way terminal block of the 1st input module (so the module which will be programmed as 001)
6	be sure that the display show [001] and the IN led is ON, on the contrary use the two direction buttons until this condition will be reached
7	push the <PRG> button: the display will show [Pro] during two seconds about, then the programmed address number will be displayed again; if the display will show [Err] (programming error) push the <PRG> button again
8	disconnect the present module and connect the next one
9	increase by a unit the displayed address pushing the up scrolling button
10	repeat the sequence from step 7 until all the input modules will be programmed
11	connect the programming cable to the first output module and repeat the sequence from 6 to 10 for all the output modules with the OUT led on

For mixed input/output module (e.g. MOD4-4S) proceed as follows:

1	connect the programming cable to the connector of the <b>CONTATTO</b> FXPRO programmer
2	turn on the <b>CONTATTO</b> FXPRO programmer pushing <ON> button; the display will show its release number during 2 seconds about, then it will show [001]; the TST led must be off
3	insert the connector on the other edge of the programming cable in the 5 terminals block of the 1st MOD4-4 module
4	be sure that the display show the desired address for the input section of the module, on the contrary use the two direction buttons until this condition will be reached; be sure that IN led be ON
5	push the <PRG> button: the display will show [Pro] during two seconds about, then the programmed address number will be displayed again; if the display will show [Err] (programming error) push the <PRG> button again
6	set the desired address for the output section using the two direction buttons, taking attention that OUT led be ON
7	push the <PRG> button: the display will show [Pro] during two seconds about, then the programmed number will be displayed again; if the display will show [Err] (programming error) push the <PRG> button again

At this point the modules are programmed and ready to be installed in the plant.

**Notes:**

- ◇ The **CONTATTO** FXPRO programmer performs the auto power off function after 30 seconds of inactivity; if this occurs during the modules programming, simply turn on again the programmer pushing the <ON> button.
- ◇ The TST led is always OFF during the programming sequence because it has not meaning when the device is in programmer mode.
- ◇ To read the number stored in a module, connect the programming cable, turn on the programmer and push the <VER> button; the display will show the number stored in the module and led IN or OUT shows the module type (for MOD4-4 press VER 2 times to read the address for both input and output section). If the display will show [Err] push the <VER> button again. If this condition persists, see Trouble Shooting

**2.2- Power supply and current consumption**

**CONTATTO** system requires a stabilized 24Vdc power supply; the system current consumption depends on the number of I/O modules connected to the system. The sizing of the power supply has to be done summing the current consumption of all the loads supplied by the same source.

For proper operation of **CONTATTO** system it is mandatory to follow the following recommendations:

- ✓ the power supply output voltage must be 24Vdc ± 25% with 5% max residual ripple
- ✓ undervoltages down to 7V are allowed for time not greater than 1msec
- ✓ overvoltages up to 33V are allowed for time not greater than 10msec
- ✓ the power supply must comply with present norms, in particular for the I/O insulation
- ✓ avoid to supply other loads by the same system power source, in particular inductive loads

Note: continuous supply voltage values higher than 30Vdc may damage the connected modules; the warranty, in this case, will expire.

### 2.3- Installation

**WARNING:** for proper operation of the system do not locate the modules near to high voltage, high frequency or high current sources.

The modules can be located anywhere along the bus, according to the installation requirement. In addition, the bus can be divided anywhere as shown, for example, by the following figure.

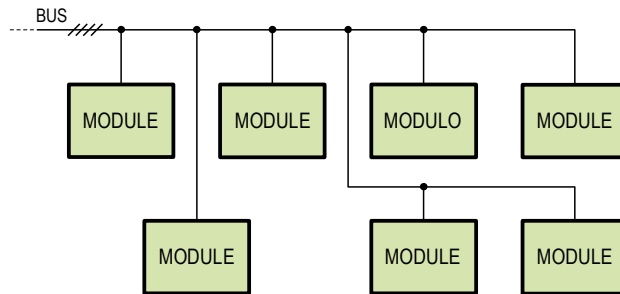

The controller location does not affect anyway the proper operation of the system .

### 2.4 Distribution of power supply by groups

It is possible to distribute the modules power supply by groups; this configuration may be suitable when the groups are very far one from the others. In this case the bus connecting the groups is made by three wires instead of four wires. The following figure shows a connection example for 2 groups of modules; remember that the controller (MCP) location does not affect the proper operation of the system.

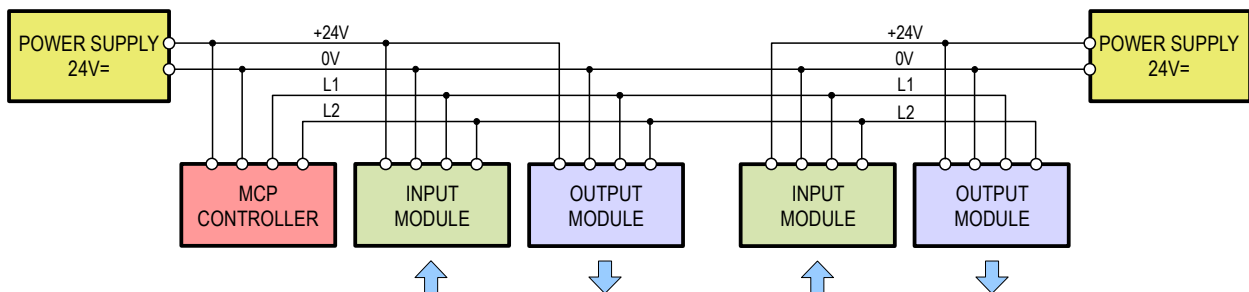

**WARNING:** if more than one power supply have been used (groups supplying), take attention that the bus connecting the several groups must be made by 3 wires, because all the terminals 14, 15, and 16 of all the modules **MUST** be connected together (in other words the 0V of all the power supplies have to be connected together).

## 2.5 Testing

Once completed the connections of all modules and power supplies as described in the previous paragraphs, be sure that no wiring errors have been made following these steps:

1. turn on all the system power supplies
2. check that LED BUS.F on the front panel of MCP controller is OFF; on the contrary, one or both lines L1 and L2 of the bus may be short circuited (each one to the other or toward the power supply); in this case check the wiring

Configure MCP controller at least with the declarations of installed module and check that the map of MCP Ide (or MCP Tools) shows correctly all modules (green background). Proceed then with the programming of MCP according to the specification of the plant.

## 3- DIAGNOSTIC

### 3.1 Visual diagnostic by the LEDs on MCP XT

MCP XT module provides the failure warning through two red LEDs on the front panel. **The red LEDs** report the alarms related to module failure (**MOD.F**) and bus failure (**BUS.F**). The MOD.F signaling occurs after 5 seconds delay time in respect to the moment of the failure of a module. The search of fault modules may be done using the MCP Ide software package, primarily displaying the map of the plant.

If both **MOD.F and BUS.F LEDs lights in continuous mode**, this means that MCP XT memory is not correctly programmed.

If a BUS FAILURE occurs, the bus connections have to be checked. This failure appears when MCP XT is not able to transmit on the bus (L1 and L2).

**Two green LEDs** on MCP XT panel report the bus activity: the **POLL** led shows the start of the polling cycle and it blinks at a frequency inversely proportional to the number of configured modules (with few connected modules this LED may seem to be fixed ON). The **VAR** led shows, through a flash, the occurrence of a status change on one or more input modules.

If the VAR LED remains ON for a long time (greater then 2 seconds), then two or more modules of the same type (IN or OUT) have the same address; in this case use MCP Ide to find the doubled addresses (the doubled modules are displayed on the screen in yellow color).

Two pairs of LEDs (red and yellow) on the front panel of MCP XT allows to monitor the activity, if any, on the two serial ports RS232 and RS485.

The following table resumes the signaling in the various operating status:

Operating status	POLL	VAR	BUS.F	MOD.F	Relay
<b>Normal</b>	Periodic blinking	Flash at the occurrence of a change on an input module	Fixed OFF	Fixed OFF	Energized
<b>Module failure</b>	Periodic blinking	Flash at the occurrence of a change on an input module	Fixed OFF	Fixed ON	De-energized
<b>Double address</b>	Periodic blinking	ON for long time	Fixed OFF	X	De-energized
<b>Bus failure</b>	Fixed OFF	Fixed OFF	Fixed ON	Fixed OFF	De-energized
<b>FLASH not programmed</b>	Simultaneous periodic blinking		Fixed ON	Fixed ON	Energized
<b>Update of main microc. or FW not valid</b>	Simultaneous periodic blinking		Alternate blinking		De-energized
<b>Update of secondary microc. or FW not valid</b>	Alternate blinking		X	X	De-energized

**Note:** The frequency of periodic blinking of POLL may be so high that LED seems to be fixed ON.  
X = don't care.

### 3.2 Visual diagnostic by the LEDs on MCP MOD or MCP Plus

MCP MOD and MCP Plus controllers feature the system failure signaling by means of two red LEDs on the front panel. **These two red LEDs** provide the module failure signaling (**MOD.F**) and bus failure signaling (**BUS.F**). The search of fault modules must be executed using the map of MCP Tools. If a bus failure occurred, the checking of the bus wiring is required. This failure occurs when MCP controller is not able to transmit on the bus (L1 and L2).

**The two green LEDs** on the panel of MCP report the activity on the bus: the **POLL** LED shows the start of the polling cycle and it blinks at a frequency inversely proportional to the number of configured modules (with few connected modules this LED may seem to be fixed ON). The **VAR** led shows, through a flash, the occurrence of a status change on one or more input modules.

If the VAR LED remains ON for a long time (greater then 2 seconds), then two or more modules of the same type (IN or OUT) have the same address; in this case use the map of MCP Tools to find the doubled addresses (the doubled modules are displayed on the screen in yellow color).

Two pairs of LEDs (red and yellow) on the front panel of MCP XT allows to monitor the activity, if any, on the two serial ports RS232 and RS485.

The following table resumes the signaling in the various operating status:

Operating status	POLL	VAR	BUS.F	MOD.F	Relay
<b>Normal</b>	Periodic blinking	Flash at the occurrence of a change on an input module	Fixed OFF	Fixed OFF	Energized
<b>Module failure</b>	Periodic blinking	Flash at the occurrence of a change on an input module	Fixed OFF	Fixed ON	De-energized
<b>Double address</b>	Periodic blinking	ON for long time	Fixed OFF	X	De-energized
<b>Bus failure</b>	Fixed OFF	Fixed OFF	Fixed ON	Fixed OFF	De-energized

**Note:** The frequency of periodic blinking of POLL may be so high that LED seems to be fixed ON. X = don't care.

### 3.3- Diagnostic by PC and MCP Ide or MCP Tools

The software package MCP Ide (or MCP Tools if using MCP MOD or MCP Plus) includes a section that allows to show on the PC the map of the modules. Each displayed module can assume different colors depending on its operating status, as here explained:

**GREEN:** the module answers correctly to MCP

**RED:** the module does not answer to MCP (it can be fault or not connected)

**YELLOW:** two or more modules have the same address

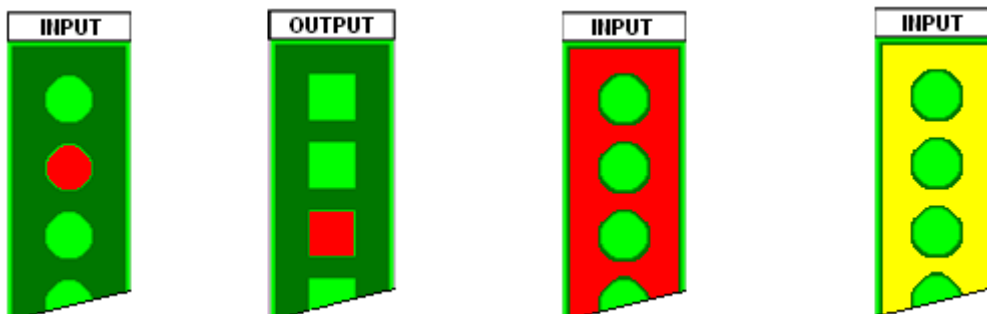

Generally, the circle reports the status of the inputs (e.g. MOD8I/A), while the square reports the status of the outputs (e.g. MOD8R); the red color means that the button or the switch is closed, or the output is ON, the green color means that the button or the switch is opened, or the output is OFF.

## 4- TROUBLE SHOOTING

Potential anomaly conditions are listed in the following, together to the related causes, the failure hypothesis and the actions needed to restore the system operation.

Unless otherwise specified, the name MCP refers indifferently to MCP XT, MCP MOD or MCP Plus.

### 4.1- MCP reports BUS.F

**MCP reports BUS.F** (and possibly MOD.F too): this means that MCP cannot communicate with the modules. This can be due to a short circuit problem between the bus wires (L1 and L2, and/or between L1 and 0V, and/or between L2 and 0V, etc.), or MCP itself has been damaged, or one or more modules have been damaged.

To find the cause of the problem proceed as follows:

- disconnect L1 and L2 from MCP (terminals 15 and 16); if applying the power supply to MCP the BUS.F led remains ON, then MCP is damaged. In this case replace MCP
- if instead the BUS.F led goes OFF, then the problem may be one of the following:
  1. the wire or the wires connecting MCP to the modules are really short circuited to some other signal
  2. one or more modules are damaged and they cause a short circuit on the bus
  3. the connection of the 4-wire bus on the terminal block of one or more modules is wrong (terminals 13, 14, 15 e 16)
  4. the 5-way terminal block of the modules are not correctly inserted

To find which of the previous cases is the relevant one, proceed as follows:

- extract **ALL** the 5-way terminal block of the bus from **ALL** the modules, or, if more modules are grouped in different electrical cabinet, disconnect the 4 wires of the bus from each cabinet
- look at the BUS.F led on MCP (checking before that all the 4 wires of the bus are connected to it)

At this point, there are **two possibilities**:

1. If **BUS.F led is still ON**, then the problem is effectively a short circuit between the bus wires, because in this condition only MCP is connected to the bus; in this case check the cable used for the bus to find the short circuit
2. If **BUS.F led has gone OFF**, then the problem is on one or more modules or it is due to a wrong connection between the bus and one or more modules; in this case proceed as follows:
  - reconnect the terminal blocks to the modules one at a time, always checking the status of BUS.F led: when this led will go ON, the last connected module is damaged or the connections to its terminal block are wrong. Check the connection and the correct insertion of the terminal block: if everything is correct, replace the module; proceed then to the insertion of the terminal block of the other modules as just described.
  - reconnect the 4 wires of the bus to one electrical cabinet at a time, always checking the status of BUS.F led: when this led will go ON, the last connected cabinet contains the fault module or a wrong connection. Extract **ALL** the 5-way terminal blocks from **ALL** the modules contained in that cabinet and then proceed as described at the previous point. Continue then to reconnect the other cabinet as just described.

## 4.2- MCP reports MOD.F

**MCP reports MOD.F:** this means that one or more modules do not answer to MCP.

**WARNING:** if also BUS.F led is ON, then refer to the previous paragraph.

**WARNING:** if VAR. led is always ON or frequently blinking refer to the following paragraph.

To find the cause of the problem proceed as follows (valid also for MCP MOD and Plus):

- connect a PC to MCP through the RS232 port
  - on the PC open the map of the modules in MCP Ide (or MCP Tools in the case of MCP MOD or Plus), after having opened the communication between the PC and MCP
  - look at the map: some modules will be shown with green background and some other ones with red background
  - take note of the address (or addresses) shown with red background and the related type (input or output)
  - search on the documentation of the plant where these modules have been placed
  - at this point, for each not operating modules, the possible causes are the following:
1. **PROGRAMMING ERROR:** if the module address has not been foreseen in the project of the system, then the problem is a programming error of MCP (in other words, MCP contains one or more wrong configuration lines or one or more equations containing a wrong address); in this case check the program, searching the wrong address (or the wrong addresses)
  2. **ADDRESS ASSIGNMENT ERROR:** check by FXPRO or FXPRO2 that the address of the module reported as fault has been correctly assigned and that the type (input/output) is correct too
  3. **CONNECTION PROBLEM OR FAULT MODULE:** in this case proceed as follows:
    - check the presence, on the fault module, of 24Vdc power supply 24Vcc between terminal 13 and 14 (where terminal 13 MUST be the positive one)
    - check the connection related to modules reported as fault: a frequent error is the reversal of signals L1 and L2 (terminals 15 and 16 of the modules)
    - check that the insulator has been removed from the wire inserted in the terminal block
    - finally, if the previous checks have not produced good results, try to replace the not operating module

**WARNING:** if all the modules reported as fault are grouped in a cabinet, this means that probably a wiring error has been done in that cabinet, or that the cable connecting the bus to that cabinet has been broken.

### 4.3- VAR led on MCP is always ON or frequently blinking

**The VAR led on MCP is always ON or it is frequently blinking** even if no changes on the inputs of the connected modules are present. In these cases one or more modules may have the same assigned address.

**WARNING:** it is normal that VAR led blinks when some status changes occur on the input modules, therefore before to conclude that the system has a malfunction, be sure that these events are not present.

To identify the doubled address proceed as follows:

- when two modules with the same address (and type) are connected to the bus, normally also the loss of a module is detected: in this case MCP may report also MOD.F, therefore refer to the previous paragraph to find the problem
- think to the possibility that the modules or some of someone of them has not been programmed before to be installed; if one or more modules have been installed as spare parts, remember that **ALSO** those ones must be addressed even if they has not been included in the equations of MCP (it is possible to assign any address, but always take in account that the modules connected to the bus **MUST HAVE ALWAYS DIFFERENT ADDRESSES**)
- open the map of the modules (on MCP Ide or MCP Tools for MCP MOD or Plus): the modules with double address will be normally shown with yellow background
- if despite the checks of the previous points the problem is still present, it is necessary to check by FXPRO or FXPRO2 the address of each connected module

### 4.4- One or more digital input modules do not communicate to MCP the correct status of their inputs

**MCP seems to be correctly working** (BUS.F and MOD.F leds are OFF, POLL. Led blinking, VAR. led OFF or blinking when a change occurs on an input module), **but one or more digital input modules do not communicate to MCP the correct status of their inputs.**

Check:

- that the common signal of the contacts connected to those input modules is correctly connected to the common of the related modules
- that the insulator of the wires inserted in the terminal of those inputs module has been correctly removed
- that the wires have not been broken
- that the wires of the inputs are not part of multi-core cables carrying also other types of signals (e.g. 230Vca or others); this can induced spurious status on the inputs of the modules (and it is also can be dangerous for the electrical safety)



### 4.5- One or more digital output modules do not control correctly the outputs

MCP seems to be correctly working (BUS.F and MOD.F leds are OFF, POLL. Led blinking, VAR. led OFF or blinking when a change occurs on an input module), **but one or more digital output modules do not control correctly the outputs.**

In this case it is very probable that a wiring error has been done between the output modules and the loads. Check the connections referring to the schematic diagram reported on the technical data sheet of the related modules.

### 4.6- Checking the voltages on the bus lines L1 and L2

When experiencing communication problems between MCP and the modules (BUS.F and/or MOD.F leds on MCP ON or blinking, background of the modules in the map of MCP Tools or MCP Ide continuously changing from red to green color in random way or less) it is possible that one or more modules have a damage to the communication interface (regardless of the fact that the address checking with FXPRO OR FXPRO2 seems to be OK or less). In these cases a check of the voltages on the bus can be useful, sometime needful; to do this, proceed as follows.

**WARNING: follow very carefully the steps here described, because on the contrary the obtained results may be meaningless.**

#### 4.6.1- FXPRO2 is available

When using FXPRO2 for the test of a bus line, it must be connected to the bus itself through the supplied adapter as shown in the figure below.

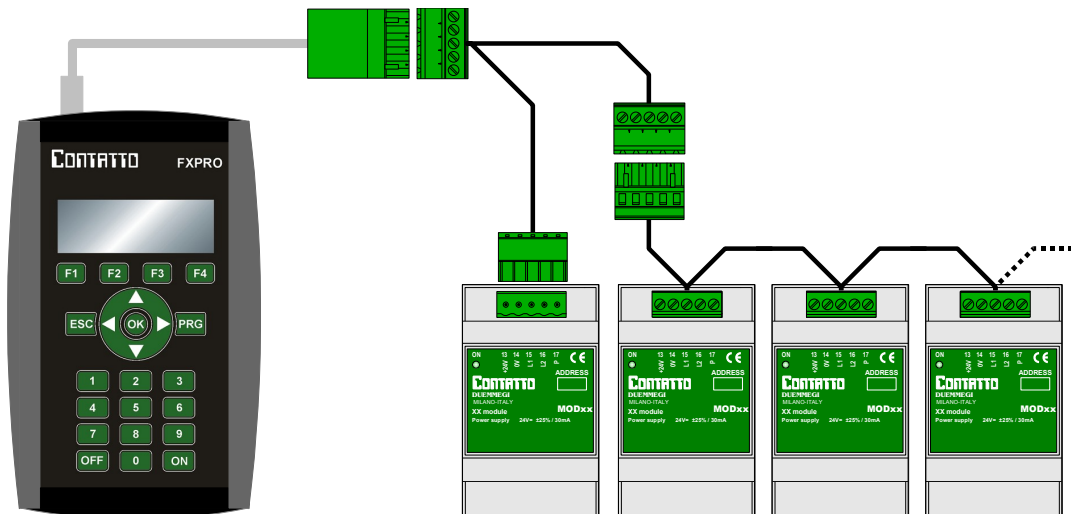

To perform the test of the line, the bus must be powered and is not necessary to disconnect the system controller (MCP XT or other).

At power on, after the screen showing the version number, the main menu will be shown:

```
> Address Management
  Tester
```

Choose the Tester option and push **OK**. The following functions have meaning only if FXPRO2 is connected to a powered bus (otherwise FXPRO2 will report a short circuit message).

```
> Check Bus Line
```

Push **OK** to access to the Check Bus Line section. The presence or absence of a controller (MCP XT) on the bus does not disturb the verification, indeed it is recommended to keep it connected. FXPRO2 will show on the display 3 lines similar to that ones shown for instance here bottom:

```
L1 22.1 2.8 OK
L2 18.9 1.1 OK
SupplyVoltage 23.2V
```

The first line shows the high and low levels of L1 (22.1 and 2.8 in the example), the second the levels of L2 (18.9 and 1.1 in the example) and the third line the value of voltage of the system (24V nominal) measured at the point of the line where FXPRO2 has been connected (23.2 in the example). At the end of the first and second line the label OK will be shown if the detected levels are normal, otherwise the label FAIL will be shown as in the following:

```
L1 22.1 1.2 OK
L2 0.5 0.3 FAIL
SupplyVoltage 23.2V
```

In this case the line L2 has a problem, probably a short circuit between L2 and 0V, the bus line will then inspected, dissecting the various sections of the bus to find out which of them has the problem. The most common problems are connection errors, short circuits between the wires of the bus or a faulty module.

If the bus line is not powered, FXPRO2 will show:

```
! WARNING! !
! SHORT CIRCUIT !
! PRESS ON AFTER !
! REMOVING SHORT !
```

#### 4.6.2- FXPRO2 is not available

1. **Extract the bus terminal (that one numbered 13..17) from MCP**, so that MCP will not be connected neither to the bus nor to the power supply, leaving connected all the other field modules
2. Using a dc voltmeter **measure the power supply voltage** on the terminal block that was inserted into MCP (and that now **MUST NOT BE** connected to MCP itself)
3. Measure now **the voltage between the terminal 14 (0V) and the terminal 15 (L1)** and check that it is equal to a little bit lower than the half of the power supply voltage (for more precision see the following table)
4. Measure now **the voltage between the terminal 14 (0V) and the terminal 16 (L2)** and check that it is equal to a little bit greater than the half of the power supply voltage (for more precision see the following table)

Supply voltage	V 14-15	V 14-16
18	7,1 ÷ 8,3	8,6 ÷ 10,1
19	7,5 ÷ 8,8	9,1 ÷ 10,7
20	7,9 ÷ 9,3	9,6 ÷ 11,2
21	8,3 ÷ 9,8	10,1 ÷ 11,8
22	8,7 ÷ 10,3	10,6 ÷ 12,4
23	9,1 ÷ 10,7	11,1 ÷ 13,0
<b>24</b>	<b>9,6 ÷ 11,2</b>	<b>11,6 ÷ 13,6</b>
25	10,0 ÷ 11,7	12,1 ÷ 14,2
26	10,4 ÷ 12,2	12,6 ÷ 14,8
27	10,8 ÷ 12,7	13,1 ÷ 15,4
28	11,2 ÷ 13,2	13,6 ÷ 16,0
29	11,6 ÷ 13,7	14,1 ÷ 16,6
30	12,1 ÷ 14,2	14,6 ÷ 17,2

**Relationship between the power supply voltage and the voltages measured between terminals 14-15 and between terminals 14-16 when MCP is not connected to the bus; the measured voltage must be in the specified range**

**If the measured voltages in both cases are in the ranges specified** in the previous table (e.g. at 24V power supply the voltage 14-15 must be in the range 9,6V to 11,2V, while the voltage 14-16 must be in the range 11,6V to 13,6V) then the bus and the connected modules are correctly working

**If instead the measured voltages are outside of the specified ranges**, this means that an error has been done, like a connection error (e.g. the reversal of L1 and L2 on one or more modules), or one or more fault modules, or a wiring problem (e.g. L1 and/or L2 in short circuit between them, or toward ground, or toward the positive, or toward the earth, etc.)

In this last case (voltage outside the correct ranges) it is necessary to locate the problem; to do this, **leaving MCP disconnected**, the best solution is to divide the bus measuring, after each division, if the two voltage 14-15 and 14-16 reenter in the correct range; when this occurs (voltages in the correct range) it means that the last section of bus that has been disconnected has a problem. At this point move to that section and repeat the measurements, further dividing the bus or extracting the bus terminal block, one at a time, of the modules connected to that section and repeating the measurements until the defective module or connection is found.